

Angle grippers HGWC

FESTO

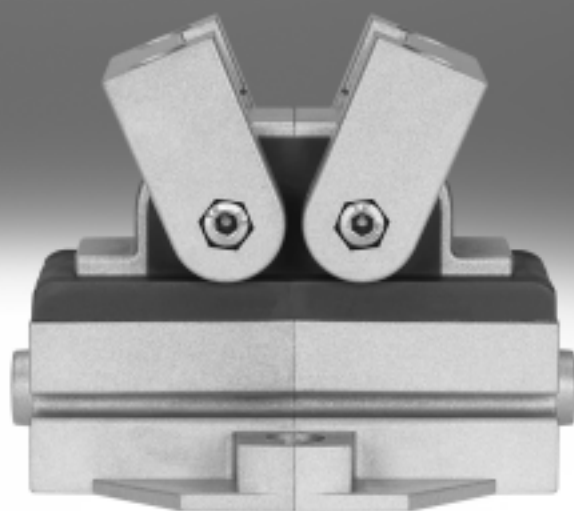

- 7 - Type discontinued
Available up until 2018

Angle grippers HGWC

Key features

FESTO

At a glance

General information

The compact and cost-optimised angle gripper consists of a two-part mirror-symmetrical housing made of die-cast zinc. The force generated by the linear motion of the piston is translated into the gripper jaw movement via a pneumatic piston, which acts directly on the gripper jaws installed in the

housing by means of a moment compensator in accordance with the rack and pinion principle. To ensure a low-backlash plain-bearing guide for the gripper jaws, appropriate guide elements are fitted in the housing and pretensioned by means of socket head screws.

- Double-acting gripper
- Internal fixed flow control, does away with the need for external flow control in 90% of applications
- High force with minimal volume
- Suitable for external and internal gripping

- Opening angle of 30°, 80°
- Wide range of options for mounting on drives
- Repetition accuracy of 0.05 mm
- Slot for proximity sensor
SME/SMT-10

- Note

Sizing software for gripper selection
→ www.festo.com

Details

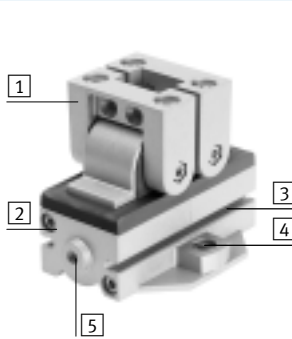

- 1 Gripper jaw
- 2 Housing based on half-shell principle
- 3 Slot for proximity sensor, for sensing the piston position
- 4 Mounting option
- 5 Supply port

Mounting option from underneath

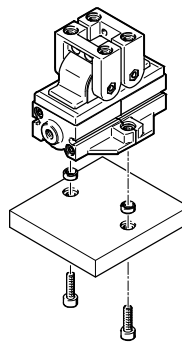

from above

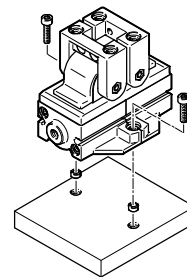

- Note

Angle grippers are not designed for the following sample applications:

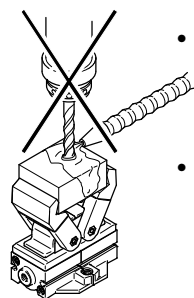

• Machining

• Aggressive media



• Grinding dust

• Welding spatter

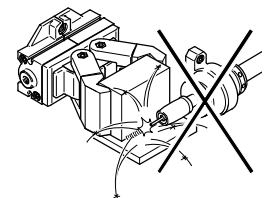

- 2 - Type discontinued
Available up until 2018

FESTO

Angle grippers HGWC

Peripherals overview and type codes

Peripherals overview

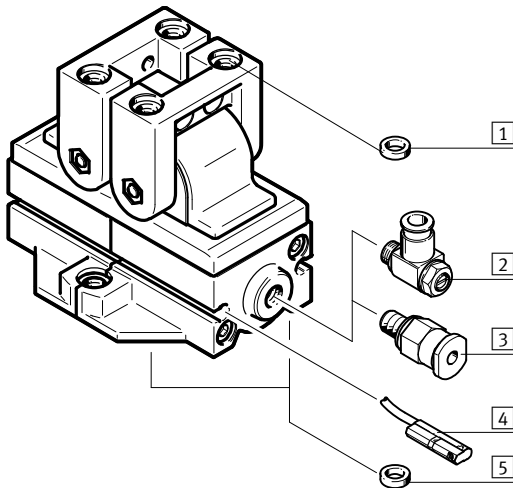

System product for handling and assembly technology

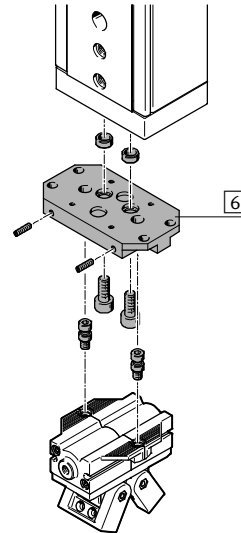

Accessories		
Type	Description	→ Page/Internet
1 Centring sleeve ZBH	<ul style="list-style-type: none"> For centring when attaching gripper fingers 4 included in the scope of delivery of the gripper 	11
2 One-way flow control valve GRLA	For regulating speed	grla
3 Push-in fitting QS	For connecting compressed air tubing with standard O.D.	qs
4 Proximity sensor SME/SMT-10	For sensing the piston position	11
5 Centring sleeve ZBH	<ul style="list-style-type: none"> For centring when attaching to a drive or plate 2 included in the scope of delivery of the gripper 	11
6 Adapter kit HAPG	Drive/gripper connections	adapter kit

Type codes

		HGWC	-	12	-	40	-	A
Type								
HGWC	Angle gripper							
Size								
Opening angle per gripper jaw								
15	15°							
40	40°							
Position sensing								
A	Via proximity sensor							

- 7 - Type discontinued
Available up until 2018

Angle grippers HGWC

Technical data

FESTO

Function
Double-acting
HGWC-...-A

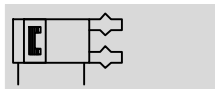

-  - Size
12, 16, 20 mm
-  - Opening angle
30° and 80°

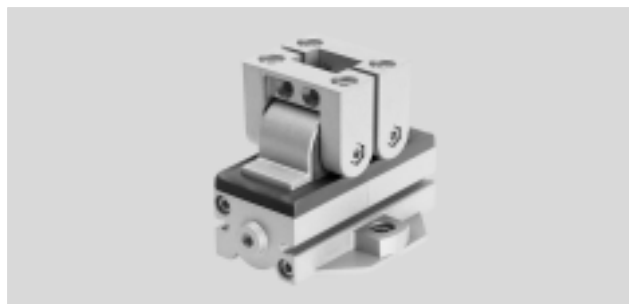

General technical data			
Size	12	16	20
Design	Rack and pinion Force-guided motion sequence		
Mode of operation	Double-acting		
Gripper function	Angle		
Number of gripper jaws	2		
Max. opening angle	[°] 30, 80		
Pneumatic connection	M5		
Repetition accuracy ¹⁾	[mm] ≤ 0.05		
Max. interchangeability	[mm] ≤ 0.2		
Max. gripper jaw backlash ²⁾	[mm] ≤ 0.1		
Max. gripper jaw angular backlash ³⁾	[°] ≤ 0.5		
Max. operating frequency	[Hz] ≤ 4		
Rotational symmetry	[mm] ≤ ∅ 0.2		
Position sensing	Via proximity sensor		
Type of mounting	Via female thread and centring sleeve		
Mounting position	Any		
Product weight	[g] 200	350	700

1) End-position drift under constant operating conditions with 100 consecutive strokes in the direction of movement of the gripper jaws

2) Perpendicular to the direction of motion of the gripper jaws

3) Pretensioned, backlash-free ball bearing guide

Operating and environmental conditions		
Operating pressure	[bar]	2 ... 8
Operating medium		Compressed air in accordance with ISO 8573-1:2010 [7:4:4]
Note on operating/pilot medium		Operation with lubricated medium possible (in which case lubricated operation will always be required)
Ambient temperature ¹⁾	[°C]	+5 ... +60
Corrosion resistance class CRC ²⁾		2

1) Note operating range of proximity sensors

2) Corrosion resistance class 2 according to Festo standard 940 070

Components subject to moderate corrosion stress. Externally visible parts with primarily decorative surface requirements which are in direct contact with a normal industrial environment or media such as coolants or lubricating agents

Angle grippers HGWC

Technical data

Materials

Sectional view

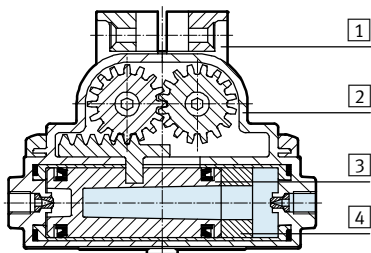

Angle gripper

1	Gripper jaw	Die-cast zinc, painted
2	Housing	Die-cast zinc, painted
3	Piston	Polyamide
4	Distance sleeve	Polyurethane
-	Seals	Polyurethane, nitrile rubber
-	Note on materials	Free of copper, PTFE and silicone RoHS-compliant

Total gripping torque at 6 bar

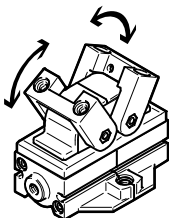

Size		12	16	20
Opening	[Ncm]	22	72	144
Closing	[Ncm]	22	72	144

Static characteristic load values at the gripper jaws

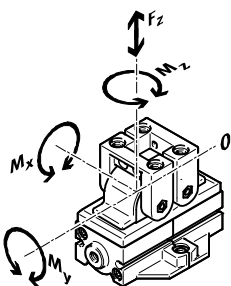

The indicated permissible forces and torques apply to a single gripper jaw. The indicated values include the lever arm, additional applied loads caused by the workpiece or external gripper

fingers, as well as forces which occur during movement.

The zero co-ordinate line (gripper jaw guide) must be taken into consideration for the calculation of torques.

Size		12	16	20
Max. permissible force F_z	[N]	40	60	80
Max. permissible torque M_x	[Nm]	2.5	4	8
Max. permissible torque M_y	[Nm]	0.6	1	1.9
Max. permissible torque M_z	[Nm]	2	3.2	6.7

- 7 - Type discontinued
Available up until 2018

FESTO

Angle grippers HGWC

Technical data

Mass moment of inertia

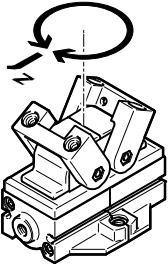

Mass moment of inertia [$\text{kgm}^2 \times 10^{-4}$] of the angle gripper in relation to the central axis with no load.

Size	12	16	20
HGWC-...-A	[$\text{kgm}^2 \times 10^{-4}$] 0.52	1.35	4.31

Opening and closing times [ms] at 6 bar

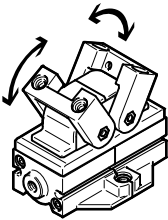

The indicated opening and closing times [ms] have been measured at room temperature and an operating pressure of 6 bar with vertically mounted gripper and without additional gripper fingers.

The grippers must be throttled for greater applied loads. Opening and closing times must then be adjusted accordingly.

Size		12-15	12-40	16-15	16-40	20-15	20-40
Without external gripper fingers							
HGWC-...-A	Opening	50	70	50	85	50	90
	Closing	35	50	35	70	35	75

Angle grippers HGWC

Technical data

Gripping force F_{Grip} per gripper jaw as a function of operating pressure and lever arm x

Gripping forces as a function of the operating pressure and the lever arm can be determined for the size using the following graph.

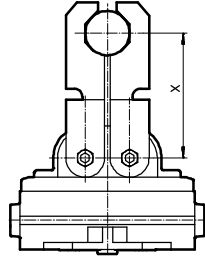

HGWC-12-A

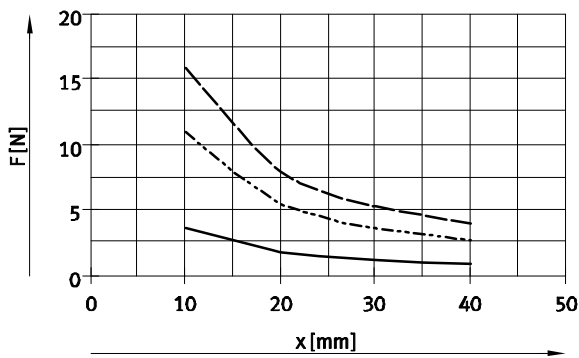

HGWC-16-A

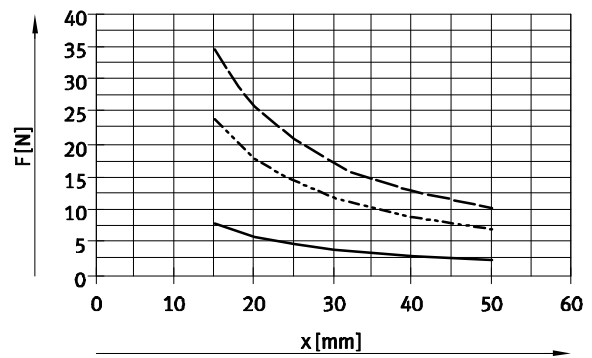

HGWC-20-A

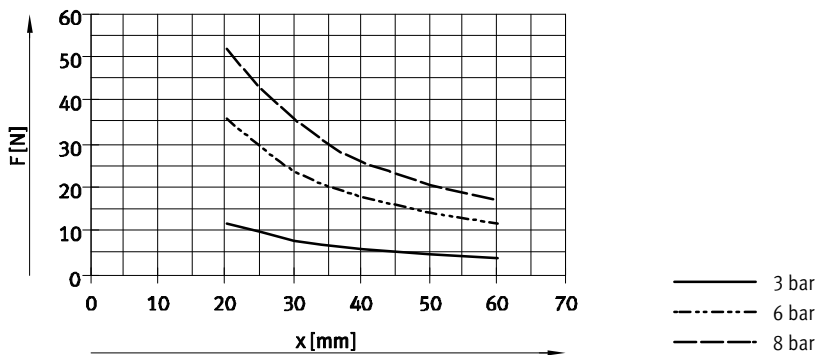

— 3 bar
- - - 6 bar
- · - 8 bar

- Type discontinued
Available up until 2018

Angle grippers HGWC

Technical data

FESTO

Dimensions

Download CAD data → www.festo.com

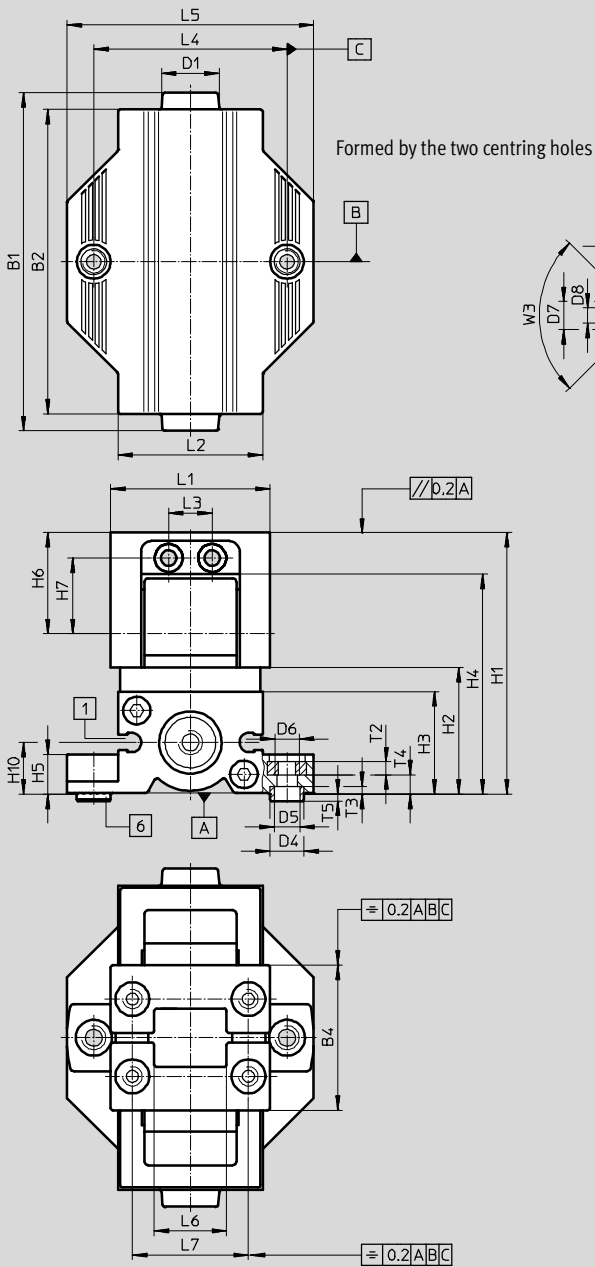

- 1 Sensor slot for proximity sensor
- 2 Supply port, opening
- 3 Supply port, closing
- 4 Gripper jaw closed
- 5 Gripper jaw open
- 6 Centring sleeves ZBH
(2 included in the scope of delivery)

- 2 - Type discontinued
Available up until 2018

FESTO

Angle grippers HGWC

Technical data

Type	B1	B2	B3 ±0.05	B4 +0.25 -0.05	B5 +0.5	B6 +0.1	D1	D2	D3 +0.05 -0.02	D4 F10/h7	D5
HGWC-12	57	52	12	23	4	11	12	M3	5	7	5.3
HGWC-16	70	63	16	30	5.5	14	12	M4	7	7	5.3
HGWC-20	86	79	20	38	6	18	12	M5	9	9	6.4

Type	D6	D7	D8	EE	H1 ±0.5	H2	H3	H4	H5	H6 ±0.2	H7
HGWC-12	M4	4.8	2.6	M5	43.2	20.7	18.2	35.2	6.9	17	12.5
HGWC-16	M5	5.8	3.2	M5	54.2	26.2	21.2	44.7	8.2	21	15.7
HGWC-20	M6	8.1	4.4	M5	68.2	32.7	27	55.7	10.2	26.5	19.5

Type	H8	H10	L1 ±0.2	L2	L3 ±0.1	L4 ¹⁾	L5	L6 +0.25 -0.05	L7 ¹⁾	T1 min.
HGWC-12	7.5	9.2	27.5	25.5	6	33	42	12	20	4.5
HGWC-16	9	10.7	33	30	9	40	51	15	24	5
HGWC-20	12	13.7	45	38	12	50	65	21	33	5

Type	T2	T3 ±0.1	T4 +0.4 -0.3	T5 +0.1 -0.3	T6 min.	T7 +0.2	T8	T9 +0.1	W1 ±2	W2 ±3	W3
HGWC-12-15	2.2	1.7	3.1	1.3	6	1.7	0.5	1.3	15°	1°	90°
40°											
HGWC-16-15	2.7	1.8	3.8	1.2	7	3	0.3	1.6	15°	1°	90°
HGWC-16-40									40°		
HGWC-20-15	3.2	2.3	5.2	1.7	9	3.5	0.5	2.1	15°	1°	90°
HGWC-20-40									40°		

1) Tolerance for centring hole ±0.03
Tolerance for thread ±0.2

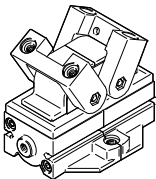
Ordering data			
	Size	Opening angle [°]	Double-acting
			Part No. Type
	12	30	565135 HGWC-12-15-A
		80	565141 HGWC-12-40-A
	16	30	565137 HGWC-16-15-A
		80	565143 HGWC-16-40-A
	20	30	565139 HGWC-20-15-A
		80	565145 HGWC-20-40-A

- 7 - Type discontinued
Available up until 2018

Angle grippers HGWC

Accessories

FESTO



Adapter kit HAPG

Material:
 Wrought aluminium alloy
 Free of copper and PTFE
 RoHS-compliant



Note

The kit includes the individual mounting interface as well as the necessary mounting material.

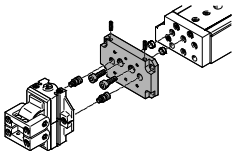
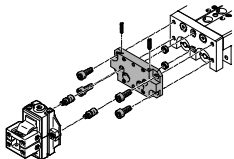
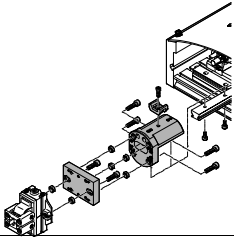
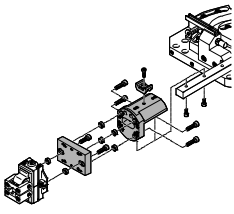
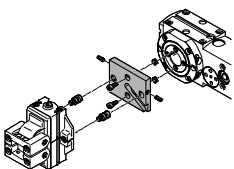
Permissible drive/gripper combinations with adapter kit							Download CAD data → www.festo.com	
Combination	Drive Size	Gripper Size	Mounting option		Adapter kit			
					CRC ¹⁾	Part No.	Type	
			■	■				
	DGSL	HGWC			HAPG			
	12, 16	12	■	■	2	529018	HAPG-58	
	20, 25	16	■	■		191267	HAPG-49	
	20, 25	20	■	■		191269	HAPG-51	
	SLT	HGWC			HAPG			
	10	12	-	■	2	542670	HAPG-100	
	16	12	-	■		529018	HAPG-58	
	16	16	-	■		542666	HAPG-101	
	20	16	-	■		191267	HAPG-49	
	20	20	-	■		542667	HAPG-102	
	25	20	-	■		191269	HAPG-51	
	HSP	HGWC				HAPG		
	16	16	-	■	2	191901	HAPG-55	
	25	20	-	■		540882	HAPG-71-B	
						191901	HAPG-55	
540883						HAPG-72-B		
	HSW	HGWC			HAPG			
	12	16	-	■	2	191901	HAPG-55	
						540882	HAPG-71-B	
	16	16	-	■		191901	HAPG-55	
540882						HAPG-71-B		
	ERMB	HGWC			HAPG			
	20	16	■	■	2	542668	HAPG-SD2-42	
						542669	HAPG-SD2-43	
						542758	HAPG-SD2-44	
20	20	■	■					
25	20	■	■					

1) Corrosion resistance class 2 according to Festo standard 940 070
 Components subject to moderate corrosion stress. Externally visible parts with primarily decorative surface requirements which are in direct contact with a normal industrial environment or media such as coolants or lubricating agents.

 Type discontinued
Available up until 2018

FESTO

Angle grippers HGWC

Accessories



Ordering data – Centring sleeves			Technical data → Internet: zbh	
For size [mm]	Part No.	Type	PU ¹⁾	
	For attachment to a drive or on a plate			
	12, 16	186717	ZBH-7	10
	20	150927	ZBH-9	10
	For attaching gripper fingers			
	12	189652	ZBH-5	10
	16	186717	ZBH-7	10
	20	150927	ZBH-9	10

1) Packaging unit

Ordering data – Proximity sensors for C-slot					
Type of mounting	Electrical connection, connection direction	Switching output	Cable length [m]	Part No.	Type
	N/O contact, magneto-resistive				
	Insertable in slot from above	Cable, 3-wire, in-line	PNP	2.5	551373 SMT-10M-PS-24V-E-2,5-L-OE
		Plug M8x1, 3-pin, in-line		0.3	551375 SMT-10M-PS-24V-E-0,3-L-M8D
N/O contact, magnetic reed					
Insertable in slot length-wise	Cable, 3-wire, in-line	Contacting	2.5	173210 SME-10-KL-LED-24	
	Plug M8x1, 3-pin, in-line		0.3	173212 SME-10-SL-LED-24	

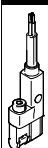
Ordering data – Proximity sensors for C-slot					
Type of mounting	Electrical connection, connection direction	Switching output	Cable length [m]	Part No.	Type
	N/O contact, magneto-resistive				
	Insertable in slot from above	Cable, 3-wire, lateral	PNP	2.5	551374 SMT-10M-PS-24V-E-2,5-Q-OE
		Plug M8x1, 3-pin, lateral		0.3	551376 SMT-10M-PS-24V-E-0,3-Q-M8D
N/O contact, magnetic reed					
Insertable in slot length-wise	Cable, 3-wire, lateral	Contacting	2.5	173211 SME-10-KQ-LED-24	
	Plug M8x1, 3-pin, lateral		0.3	173213 SME-10-SQ-LED-24	

Ordering data – Proximity sensors for C-slot					
Type of mounting	Electrical connection, connection direction	Switching output	Cable length [m]	Part No.	Type
	N/O contact, magneto-resistive				
	Insertable in slot length-wise	Cable, 3-wire, lateral	PNP	2.5	547862 SMT-10G-PS-24V-E-2,5Q-OE
		Plug M8x1, 3-pin, lateral		0.3	547863 SMT-10G-PS-24V-E-0,3Q-M8D

Ordering data – Connecting cables				Technical data → Internet: nebu	
Electrical connection, left	Electrical connection, right	Cable length [m]	Part No.	Type	
	Straight socket, M8x1, 3-pin	Cable, open end, 3-wire	2.5	541333	NEBU-M8G3-K-2.5-LE3
			5	541334	NEBU-M8G3-K-5-LE3
	Angled socket, M8x1, 3-pin	Cable, open end, 3-wire	2.5	541338	NEBU-M8W3-K-2.5-LE3
			5	541341	NEBU-M8W3-K-5-LE3